

PISTON PRESSURE SWITCH type IPH



Characteristics

TYPE	PRESSURE SETTING RANGE	REPEATABILITY	WEIGHT
IPH-035	6-35 bar	$\pm 1\%$ of setting	0.35 Kg.
IPH-150	12-150 bar		
IPH-350	30-350 bar		
IPH-630	50-630 bar		

Description

Piston operated, fixed differential, electro-hydraulic pressure switch equipped with electric contact in exchange. When pre-set pressure is achieved, the piston actuates a microswitch. The setting adjustment is achieved by means of a grub screw (R).

Dimensions

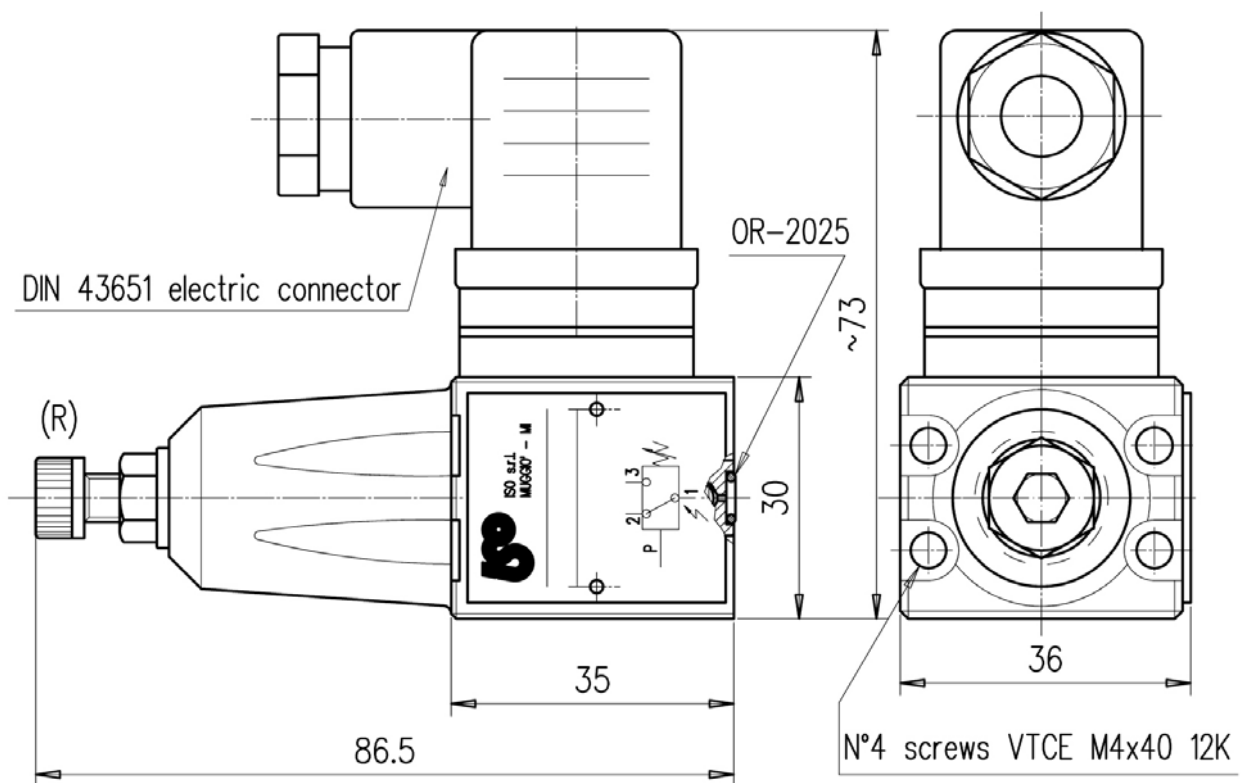

Symbol

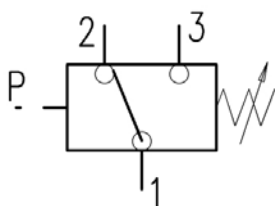

Contacts

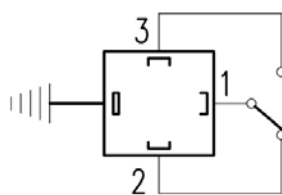

Flange interface

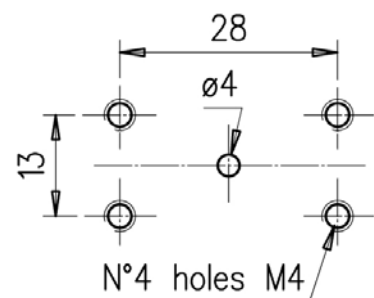

PISTON PRESSURE SWITCH type IPH



Electric characteristics

	125 AC	250 AC	30 DC	150 DC
Max voltage (Rated load)	7 Amp.	5 Amp.	5 Amp.	0.2 Amp.
Connection frequency	Max. 120 cycles/min			
Protection	IP-65			
Direct current with inductive load	It is suggested to provide an arching contact			

Diagram

DIFFERENTIAL PRESSURE OF IPH-35 PRESSURE SWITCH

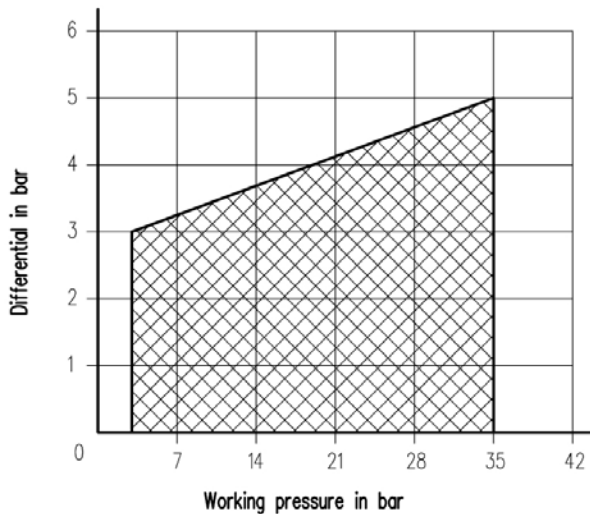

DIFFERENTIAL PRESSURE OF IPH-150 PRESSURE SWITCH

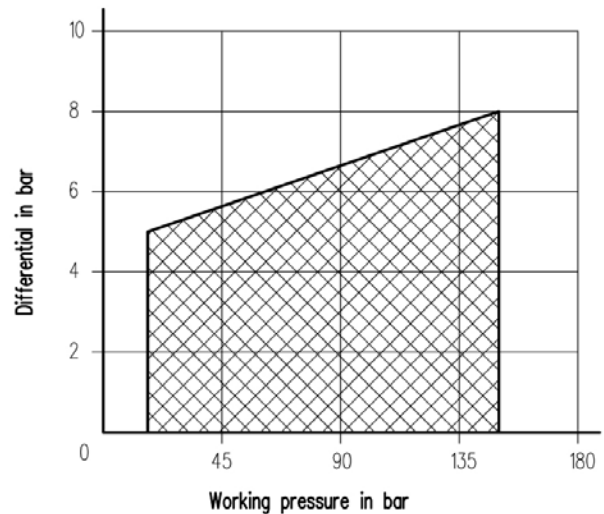

DIFFERENTIAL PRESSURE OF IPH-350 PRESSURE SWITCH

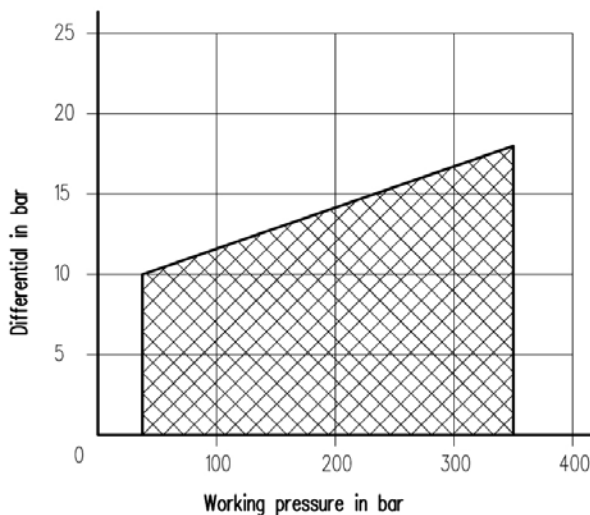

DIFFERENTIAL PRESSURE OF IPH-630 PRESSURE SWITCH

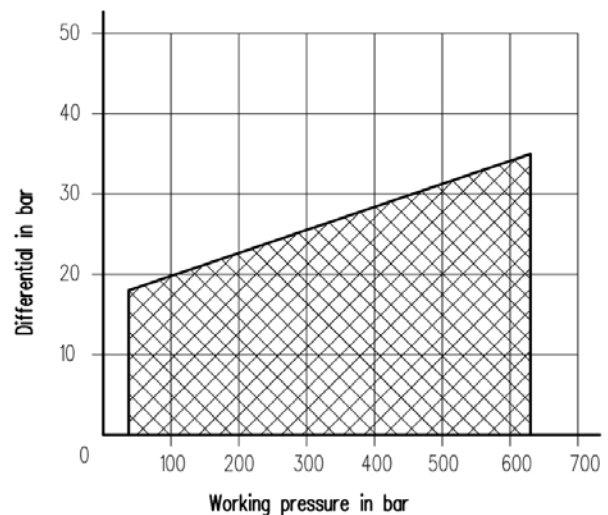



Adaptor

APM-14

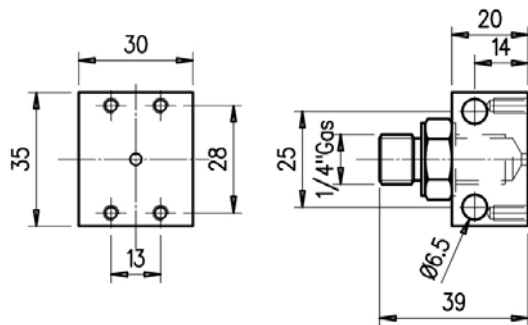

It allows the pressure switch mounting:
 - panel-mounted adaptor by using n.2 \varnothing 6.5 holes
 - equipped with 1/4" BSP nipple

APM-14-1/4x8

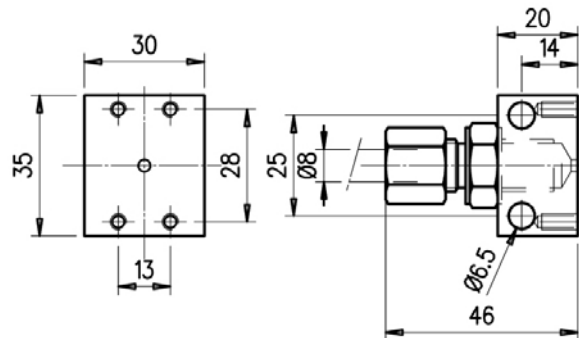

It allows the pressure switch mounting:
 - panel-mounted adaptor by using n.2 \varnothing 6.5 holes
 - equipped with 1/4" BSP tang for \varnothing 8 hose

APH-14

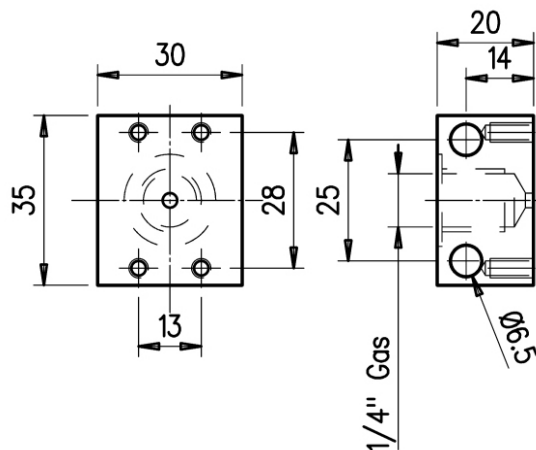

It allows the pressure switch mounting: panel-mounted adaptor by using n.2 \varnothing 6.5 holes.

SBM-03/210-IP-**

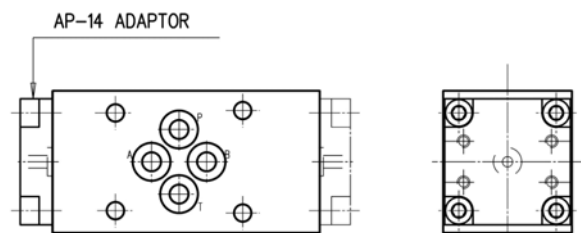

When you order, replace the asterisks with the port/ports on which the device will be mounted.
 Es. SBM-03/210-IP-B = Pressure switch operating on B port.

AP-14

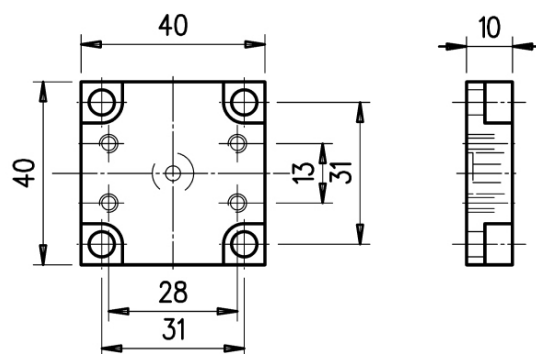

It allows the pressure switch mounting:
 - as a replacement of pressure switches type IP
 - together with modular subplate type SBM (see on side)

SBM-05/210-IP-**

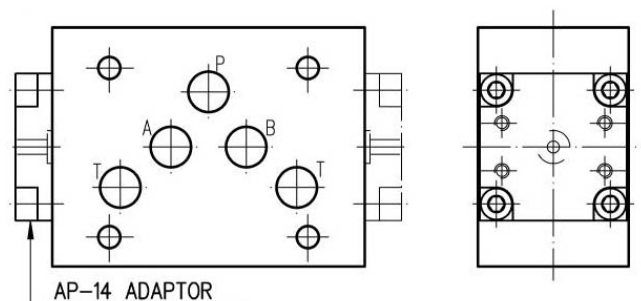

When you order, replace the asterisks with the port/ports on which the device will be mounted.
 Es. SBM-05/210-IP-B = Pressure switch operating on B port.



Installation rules

- The pressure switches type IPH can be mounted in any position
- Fluid to be used: hydraulic oil in compliance with DIN 51524 rules, viscosity between 30 and 100 mm²/s (cSt) at 40°C
- Recommended filtration of 25µ
- Hydraulic fluid temperature: from -20° to +75°C

Ordering code

IPH - ***
└─┬─┘ Pressure setting : 035=6-35 bar 150=12-150 bar 350=30-350 bar 630=50-630 bar
└─┘ Pressure switch

The product has not to be used as safety device as stated in Article 1, paragraph 2, letter D of Legislative Decree N° 93 dated 25/02/2000.

The component has been designed and manufactured meeting the requirements stated in Directive 97/23/CE (Legislative Decree N° 93/00).

The component is included in the category provided in Article 3, paragraph 3, for which it can be commercialized without CE marking.