

# CONTINUUM® PUMPS

Patents Garanted  
Brevetti approvati

Helical rotor pumps for high pressure and low noise application

Pompe a rotori elicoidali per applicazioni ad alta pressione e basso rumore

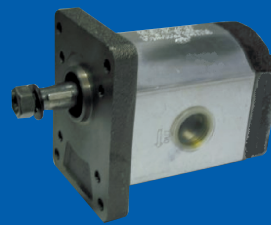
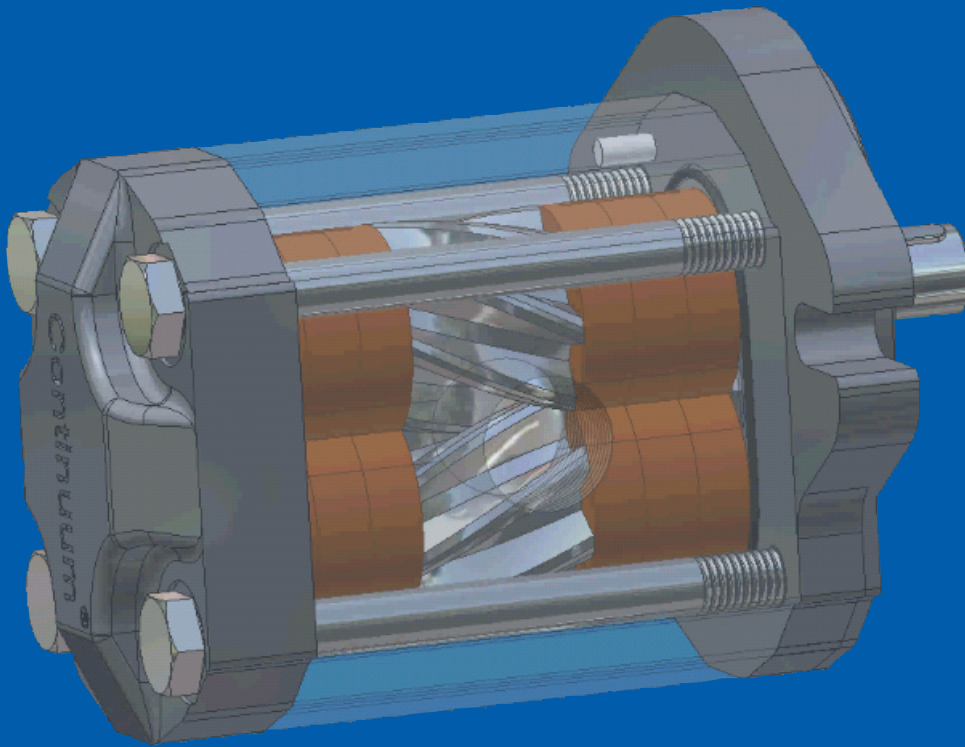

**SETTIMA**   
*flow mechanisms*

## CONTINUUM® PROJECT

### Sustainable Power

In a ever increasing demand for power, designers and manufacturers of hydraulic devices have explored all opportunities to contain noise and reduce ripple. When System Life Cycle, Environmental Conditions, Energy Consumption, and Performance are paramount the ultimate solution is to cut the problem at its root.

### Noise is Expensive

From small steering systems to large municipal equipment, from a lubrication system to a forklift, noise is not only generated by the pumps, but in most cases the system generates noise by amplifying the ripple. Consequent pressure drops are a noticeable energy consumer and reduce overall efficiency. Even in the most demanding conditions Continuum enables the system designer to focus on functions and features, reducing customer frustration by eliminating expensive enclosures, hoses and attenuators. Noise is relieved at the root.

### Power of Silence

Our product looks like the most popular of hydraulic pumps, the Gear pump, but their the similarity ends. Continuum is set to transform the way end users perceive hydraulic devices. The ultimate solution for preserving the experience of silence. Settima FM, introducing its new Continuum Product Line, is paving the way for Sustainable Fluid Power.

### The Human Factor

As well as investing in the most advanced design and manufacturing capability, Settima Flow Mechanisms base the quality of their value chain on the human factor. Encouraging innovation and personal responsibility, Settima has reached a high standard of quality and an extremely flexible manufacturing system.

## The Continuum® Principle

Investing in innovation is about empowering impressive and revolutionary ideas. Such as the one embraced by Continuum, a new pumps with continuous intermeshing, no-leaking rotors.

### Technological innovation for HIGH pressure, LOW noise and LOW pulsations

The Continuum® concept is based on three patented breakthroughs:

- the rotors profile
- the screw step
- the inner force balancing

## PROGETTO CONTINUUM®

### Potenza sostenibile

Per far fronte alla crescente domanda di potenza, progettisti e costruttori di dispositivi idraulici hanno esplorato tutte le opportunità per contenere il rumore e ridurre le pulsazioni del circuito. Quando la durata della vita del sistema, le condizioni ambientali, i consumi e le funzionalità sono fondamentali l'ultima soluzione è quella di tagliare il problema alla radice.

### Il rumore è costoso

Dal piccolo sistema di sterzo all'ingombrante apparato della nettezza urbana, dal sistema di lubrificazione al carrello elevatore. Il rumore non solo è generato dalle pompe idrauliche, ma nella maggior parte dei casi il sistema genera rumore amplificando la pulsazione di pressione. Le perdite di carico conseguenti sono un considerevole consumo di energia e sorgente di una inefficienza complessiva. Persino nelle condizioni più esigenti Continuum® abilita il progettista di sistema ad implementare nuove funzioni e proprietà non solo a ridurre la frustrazione del cliente mediante costosi attenuatori, tubi flessibili e contenitori. Il Rumore e' rimosso alla radice.

### Il potere del silenzio

Dotata delle dimensioni e flangiature dei dispositivi idraulici più diffuse come le pompe ad ingranaggi, Continuum® è pronta a trasformare il modo in cui l'utente finale percepisce il dispositivo idraulico. La soluzione definitiva per preservare l'esperienza del silenzio. Settima FM,

introducendo la sua nuova linea di prodotti Continuum®, prepara la strada per una Potenza Fluida Sostenibile.

### Il fattore umano

Al di là degli investimenti in capacità di progettazione e produttive Settima Flow Mechanisms e l'intera filiera produttiva basano la loro qualità sul fattore umano. Incoraggiando l'innovazione e la responsabilità personale, Settima FM ha raggiunto un alto standard di qualità e una produzione estremamente flessibile.

## Il principio Continuum®

Investire in innovazione significa dare valore a idee rivoluzionarie. Così come quella adottata da Continuum, una nuova pompa con rotori a contatto continuo e senza perdite.

### Innovazione tecnologica per ALTA pressione, BASSO rumore e BASSE pulsazioni

Il Concetto Continuum® e' basato su tre innovazioni brevettate:

- il profilo dei rotori
- il passo della vite
- il bilanciamento delle forze interne

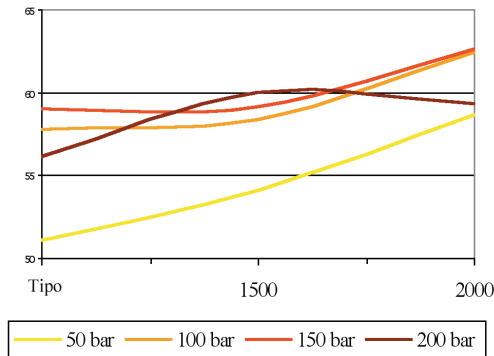

## Pressure Ripple and Noise Analysis

The current designs of high pressure gear pumps permit a quantity of fluid to be trapped and compressed between the gear teeth with the following consequences:

- sharp changes in pressure growth
- noise (increasing rapidly above 1500 rpm)

The continuum design concept achieves one main design objective:

- total absence of trapped and compressed oil between the gears;
- no trade-offs in material selection or treatment.

This results in:

- smooth changes in pressure growth
- HIGH Efficiency
- LOW noise (up to 5.000 rpm)

The pressure ripple laboratory test shows the impressive improvement of the pulsation in a Continuum® designed pump (pressure sampling at 100 KHz) while maintaining excellent efficiency.

The noise laboratory test shows the impressive improvement of the noise curve in a Continuum® designed pump.

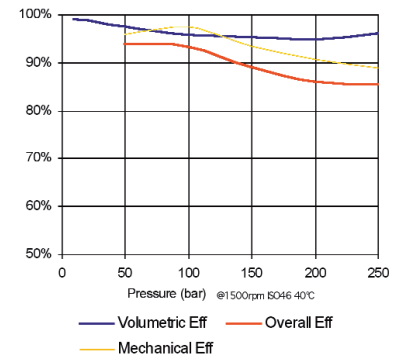
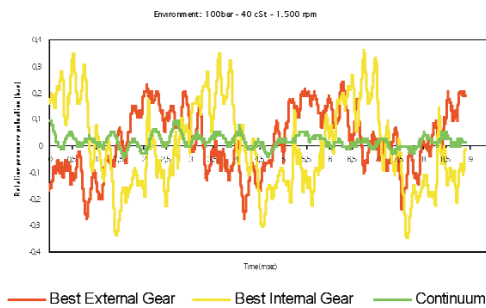
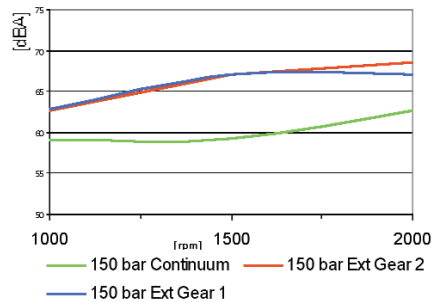

## Analisi della pulsazione di pressione e del rumore

L'attuale struttura di pompe ad ingranaggi per alta pressione tipicamente implica camere di compressione del fluido tra denti delle ruote dentate.

Conseguentemente si osservano:

- rapide variazioni nella pressione
- rumore (a partire da 1.500 rpm)

Il concetto di progettazione Continuum® consente un principale obiettivo di progettazione:

- totale assenza di camere di alta pressione di olio compresso nell'ingranaggio;
- nessun compromesso su selezione materiale e sui trattamenti degli stessi.

Questo implica:

- smorzate variazioni di crescita di pressione
- ALTE efficienze
- BASSO rumore (fino a 5.000 rpm)

I test di Pulsazione della Pressione mostrano un miglioramento impressionante sulla pulsazione nelle pompe Continuum® (con pressione campionata a 100KHz) pur mantenendo efficienze eccellenti.

I test di laboratorio di rumore mostrano un significativo miglioramento delle curve di rumore.

## Detailed technical information / Informazioni tecniche dettagliate

Models available / Modelli Disponibili	GR28 - GR33 - GR38 - GR47 - GR55 - GR72	
Flanges / Flange	Group 1 - Group 2 (European, German, BKT, SAE-A) - Group 3 (European, SAE-B) Gruppo 1 - Gruppo 2 (Europeo, Tedesco, BKT, SAE-A) - Gruppo 3 (Europeo, SAE-B) ISO 3019/2 - IEC standard (per accoppiamento diretto)	
Connections / Conessioni	GAS - SAE 3/4" 3000 PSI - FL 4 HOLES M6 SU Ø40 DN20 (***) / GAS - SAE 3/4" 3000 PSI FL 4 HOLES M6 SU Ø40 DN20 (***)	
Installation position / Posizione di installazione	External, underoil / Esterna e immersa	
Shaft rotation / Rotazione albero	Clockwise / Destra (standard)	
Shaft speed / Velocità di rotazione	From 700 to 3.600 rpm (for GR72 to 2200RPM) / Da 700 a 3.600 rpm (per GR72 a 2200 RPM)	
Displacements - Flows / Dislocamento - Flusso	From 4 up to 200 cm <sup>3</sup> - From 6L/min up to 300L/min (at 1.500 rpm) / Da 4 a 200 cm <sup>3</sup> - Da 6L/min a 300L/min (a 1.500 rpm)	
Operating pressure (*) / Pressione operativa (*)	Continuous: 240 bar Cycle ON/OFF: 250 bar Peak: 280 bar	Continuo: 240 bar Ciclo ON/OFF: 250 bar Picco: 280 bar
Inlet pressure / Porta di ingresso	0,8 - 2 bar (****) / 0,8 - 2 bar (****)	
Fluids / Fluidi	Mineral oil HLP e HLVP - Ecologic fluids HETG-HEPG-HEE - Synthetic fluid or emulsion: (**) HFA oil-water emulsion - (**) HFB water-oil emulsion - (**) HFDR phosphate ester	Olii minerali HLP e HLVP - Fluidi ecologici HETG - HEPG - HEE Fluidi sintetici o emulsioni: (**) HFA emulsione acqua-olio - (**) HFB emulsione acqua-olio - (**) HFDR estere fosfato
Viscosity / Viscosità	Permissible (**): from 20 up to 800 mm <sup>2</sup> /s [cSt] Recommended: from 24 up to 150 mm <sup>2</sup> /s [cSt] Starting conditions (**): up to 3.000 mm <sup>2</sup> /s [cSt]	Consentita (**): da 20 a 800 mm <sup>2</sup> /s [cSt] Raccomandata: da 24 a 150 mm <sup>2</sup> /s [cSt] Condizioni di avviamento (**): fino a 3.000 mm <sup>2</sup> /s [cSt]
Environment temperature / Temperatura ambiente	From -15° up to +60°C / Da -15° a +60°C	
Hydraulic temperature / Temperatura idraulica	From -15° up to +80°C / Da -15° a +80°C	
Contamination Level / Livello di contaminazione	From 10 NAS (21/9/15 ISO4406) to 8 NAS (18/17/14 ISO4406) for heavy duty operations (*****) Da 10 NAS (21/9/15 ISO4406) a 8 NAS (18/17/14 ISO4406) per operazioni pesanti (*****)	
Filtration / Filtrazione	Inlet Port: from 50 to 30 µm for heavy duty operations (*****) Outlet Port: from 25 to 10 µm for heavy duty operations (*****) Porta d'ingresso: da 50 a 30 µm per operazioni pesanti (*****) Porta d'uscita: da 25 a 10 µm per operazioni pesanti (*****)	
Seals / Guarnizioni	NBR, FKM, FPM, EPDM - Special on request / NBR, FKM, FPM, EPDM - Speciali su richiesta	
Noise / Rumore	from 52 up to 63 dB(A) at 2.950 rpm - Value based on ISO 4412 test procedure / da 52 a 63 dB(A) a 2.950 rpm - Valore rilevato con procedura ISO 4412	
Flanges / Flange	Cast Iron / Ghisa	
Pump body (standard) / Corpo pompa (standard)	Extruded aluminium alloy / Alluminio estruso	
Screw / Viti	Case hardened grinded steel / Acciaio temperato	
Maintenance / Manutenzione	No / Nessuna	

(\*) Test executed with Oil ISO VG46 (40°C) - 10µm filtration - (\*\*) Please contact the company to have further details - (\*\*\*) Available on certain models upon customer request  
(\*\*\*\*) Up to 10 bar Shaft Seal available on certain models upon request - (\*\*\*\*\*) Heavy Duty operation are defined as above 150bar , more than 4h/day, more than 100 cycle/day, oil ISO 46

(\*) Test eseguito con Olio ISO VG46 (40°C) - filtrazione a 10µm - (\*\*) Per maggiori dettagli contatta i nostri uffici - (\*\*\*) Disponibile su alcuni modelli su richiesta  
(\*\*\*\*) Anello di tenuta dell'albero fino a 10 bar disponibili su alcuni modelli - (\*\*\*\*\*) Operazioni Pesanti sono definite come sopra 150bar , piu' di 4h/day, oltre 100 cicli/giorno con olio ISO 46.



## Dimensional drawing - GR28

Shaft types & dimensions

## Disegni dimensionali - GR28

Tipo albero e dimensioni

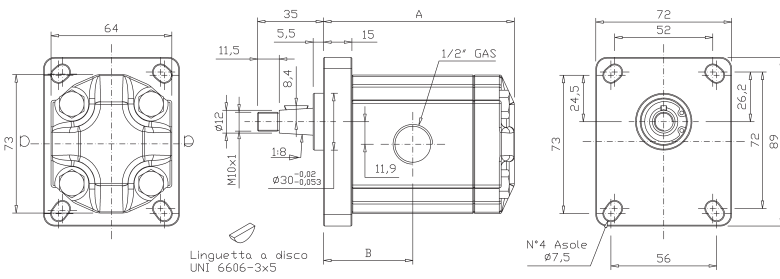

### Type / Tipo 1-C3

Type / Tipo	CC	L/min	Dim A	Dim B	Cont Press (*)	Interm Press(*)	Peak / Press Press(*)	Noise / Livello Picco Level / Rumore
4	4,2	6	95,6	44,55	275	280	300	55
6	6,4	9,2	101,1	47,3	275	280	300	55
8	8,3	12,0	106,1	49,8	246	260	280	55
10	10,2	14,7	111,1	52,3	222	250	270	55
13	12,9	18,6	118	55,75	176	230	250	55

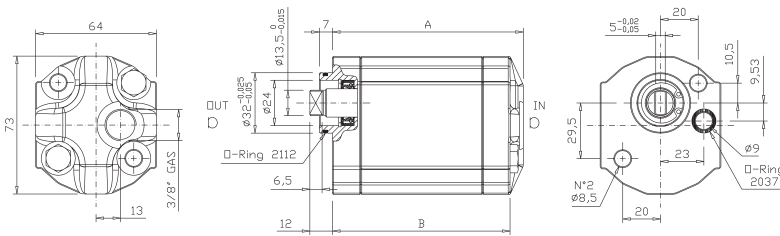

### Type / Tipo 1L-GL54

Type / Tipo	CC	L/min	Dim A	Cont Press (*)	Interm Press(*)	Peak Press(*)	Noise Level
4	4,2	6	95,6	275	280	300	55
6	6,4	9,2	101,1	275	280	300	55
8	8,3	12,0	106,1	246	260	300	55
10	10,2	14,7	111,1	222	250	300	55
13	12,9	18,6	118	176	230	280	55

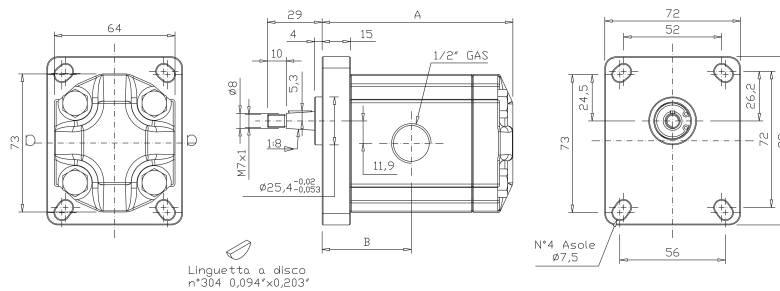

### Type / Tipo 1P-C2

Type / Tipo	CC	L/min	Dim A	Dim B	Cont Press (*)	Interm Press(*)	Peak / Press Press(*)	Noise / Livello Picco Level / Rumore
4	4,2	6	95,6	44,55	275	280	300	55
6	6,4	9,2	101,1	47,3	275	280	300	55
8	8,3	12,0	106,1	49,8	246	260	280	55
10	10,2	14,7	111,1	52,3	222	250	270	55
13	12,9	18,6	118	55,75	176	230	250	55

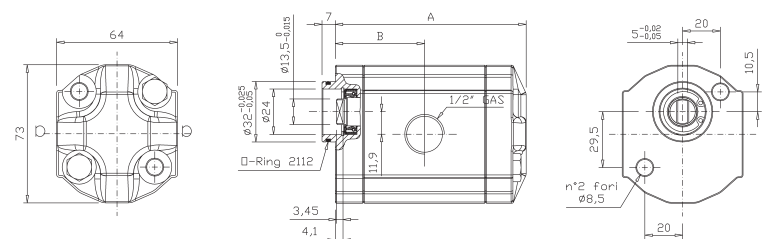

### Type / Tipo 1K-G54

Type / Tipo	CC	L/min	Dim A	Dim B	Cont Press (*)	Interm Press(*)	Peak / Press Press(*)	Noise / Livello Picco Level / Rumore
4	4,2	6	95,6	44,55	275	280	300	55
6	6,4	9,2	101,1	47,3	275	230	250	55
8	8,3	12,0	106,1	49,8	246	195	215	55
10	10,2	14,7	111,1	52,3	222	170	190	55
13	12,9	18,6	118	55,75	176	140	160	55

(\*) Intermittent: cycle 20 sec. ON & 3 sec. OFF - Peak: cycle 1 sec. ON & 3 sec. OFF  
 (\*) Intermittente: ciclo 20 sec. ON & 3 sec. OFF - Picco: ciclo 1 sec. ON & 3 sec. OFF

## Dimensional drawing - GR33

Shaft types & dimensions

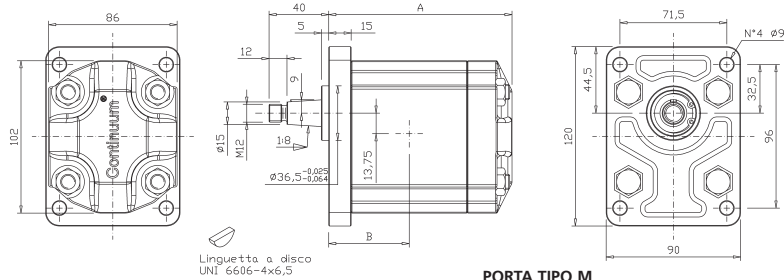

Linguetta a disco  
UNI 6606-4x6,5

PORTA TIPO G

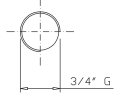

PORTA TIPO M

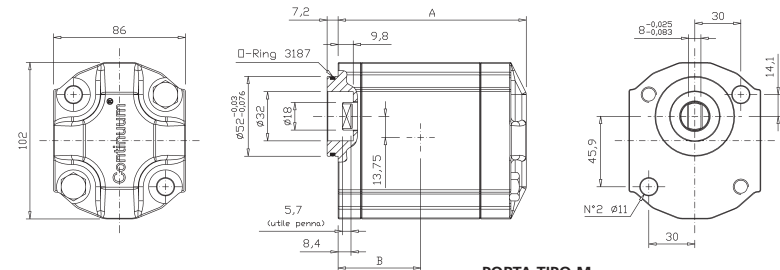
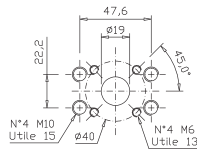

PORTA TIPO G

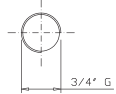

PORTA TIPO M

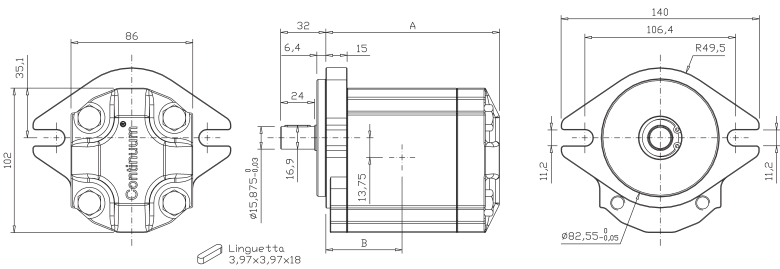
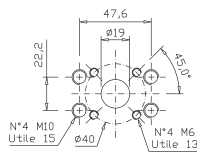

Linguetta  
3,97x3,97x18

PORTA TIPO G

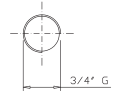

PORTA TIPO M

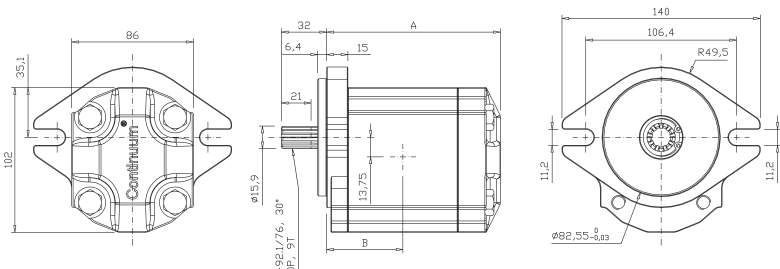
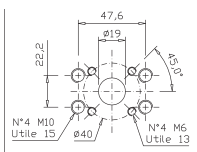

ANSI-B-92.1.7.6, 30°  
16/32=DP, 9T

PORTA TIPO G

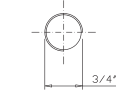

PORTA TIPO M

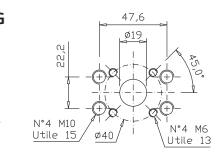

## Disegni dimensionali GR33

Tipo albero e dimensioni

### Type / Tipo 2-C4

Type / Tipo	CC	L/min	Dim A	Dim B	Cont Press (*)	Interm Press(*)	Peak / Press Press(*)/Picco	Noise / Livello Level/Rumore
10	10,1	14,5	122,6	53,8	275	280	300	55
13	12,6	18,1	127,5	56,25	265	270	290	55
15	15,2	21,8	132,5	58,75	241	250	270	55
18	18,2	26,1	138,3	61,65	206	250	270	55

### Type / Tipo 2BK7-G54

Type / Tipo	CC	L/min	Dim A	Dim B	Cont Press (*)	Interm Press(*)	Peak / Press Press(*)/Picco	Noise / Livello Level/Rumore
10	10,1	14,5	122,6	53,8	275	280	300	55
13	12,6	18,1	127,5	56,25	265	270	290	55
15	15,2	21,8	132,5	58,75	241	250	270	55
18	18,2	26,1	138,3	61,65	206	250	270	55

### Type / Tipo SAEA-AC

Type / Tipo	CC	L/min	Dim A	Dim B	Cont Press (*)	Interm Press(*)	Peak / Press Press(*)/Picco	Noise / Livello Level/Rumore
10	10,1	14,5	122,6	53,8	275	280	300	55
13	12,6	18,1	127,5	56,25	265	270	290	55
15	15,2	21,8	132,5	58,75	241	250	270	55
18	18,2	26,1	138,3	61,65	206	250	270	55

### Type / Tipo SAEA-T9

Type / Tipo	CC	L/min	Dim A	Dim B	Cont Press (*)	Interm Press(*)	Peak / Press Press(*)/Picco	Noise / Livello Level/Rumore
10	10,1	14,5	122,6	53,8	275	280	300	55
13	12,6	18,1	127,5	56,25	265	270	290	55
15	15,2	21,8	132,5	58,75	241	250	270	55
18	18,2	26,1	138,3	61,65	206	250	270	55

(\*) Intermittent: cycle 20 sec. ON & 3 sec. OFF - Peak: cycle 1 sec. ON & 3 sec. OFF  
(\*) Intermittente: ciclo 20 sec. ON & 3 sec. OFF - Picco: ciclo 1 sec. ON & 3 sec. OFF

**Dimensional drawing - GR38**

Shaft types & dimensions

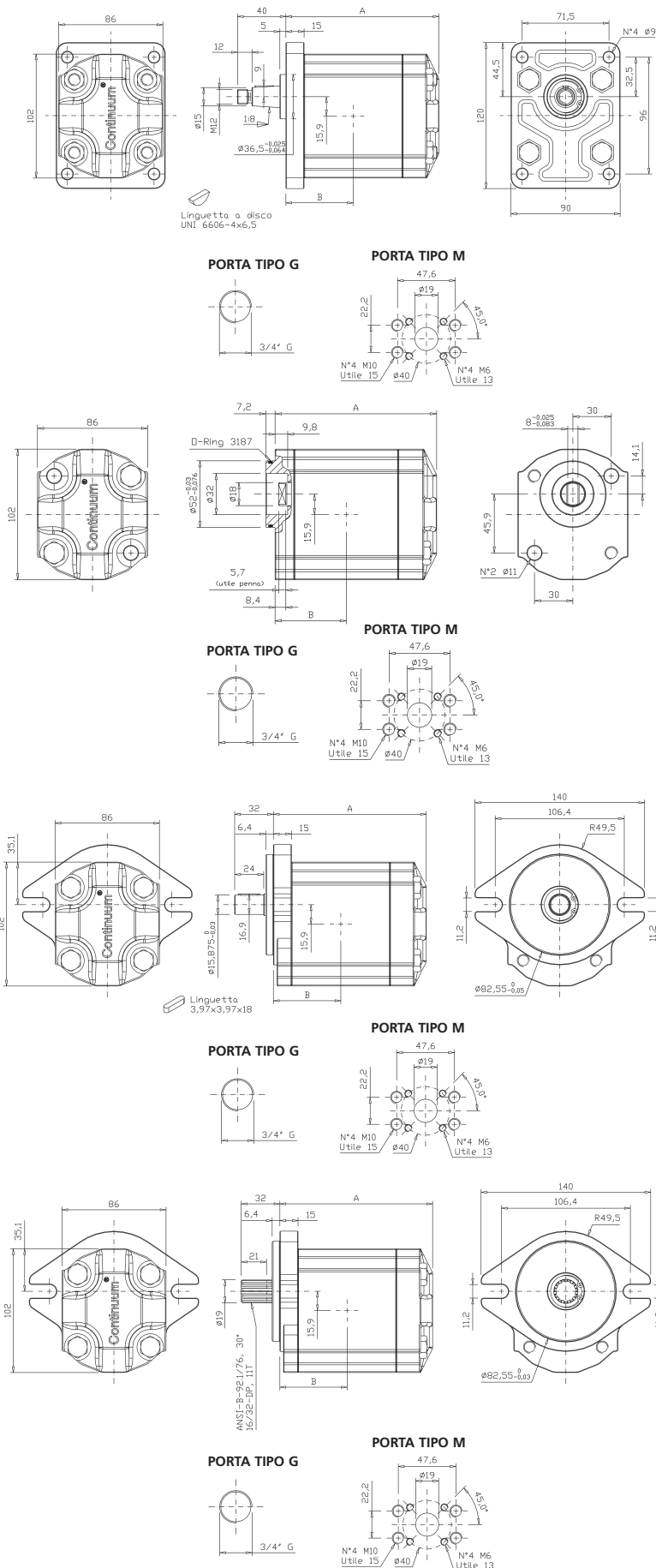

*Disegni dimensionali GR38*

*Tipo albero e dimensioni*

**Type / Tipo 2-C4**

Type / Tipo	CC	L/min	Dim A	Dim B	Cont Press (*)	Interm Press(*)	Peak / Press / Livello Press (*) / Picco / Rumore Level / Rumore
16	15,9	22,8	126,1	55,55	265	280	300 55
18	17,9	25,8	129,1	57,05	247	260	280 55
20	20	28,8	132,1	58,55	230	250	270 55
22	22,1	31,8	135,1	60,05	222	250	270 55
25	25,2	36,2	139,6	62,3	208	250	270 55
28	28,3	40,7	144,1	64,55	197	250	270 55

**Type / Tipo 2BK7-G**

Type / Tipo	CC	L/min	Dim A	Dim B	Cont Press (*)	Interm Press(*)	Peak / Press / Livello Press (*) / Picco / Rumore Level / Rumore
16	15,9	22,8	126,1	55,55	265	280	300 55
18	17,9	25,8	129,1	57,05	247	260	280 55
20	20	28,8	132,1	58,55	230	250	270 55
22	22,1	31,8	135,1	60,05	222	250	270 55
25	25,2	36,2	139,6	62,3	208	250	270 55
28	28,3	40,7	144,1	64,55	197	250	270 55

**Type / Tipo SAEA-AC**

Type / Tipo	CC	L/min	Dim A	Dim B	Cont Press (*)	Interm Press	Peak / Press / Livello Press / Picco / Rumore Level / Rumore
16	15,9	22,8	126,1	55,55	265	280	300 55
18	17,9	25,8	129,1	57,05	247	260	280 55
20	20	28,8	132,1	58,55	230	250	270 55
22	22,1	31,8	135,1	60,05	222	250	270 55
25	25,2	36,2	139,6	62,3	208	250	270 55
28	28,3	40,7	144,1	64,55	197	250	270 55

**Type / Tipo SAEA-T11**

Type / Tipo	CC	L/min	Dim A	Dim B	Cont Press (*)	Interm Press	Peak / Press / Livello Press / Picco / Rumore Level / Rumore
16	15,9	22,8	126,1	55,55	265	280	300 55
18	17,9	25,8	129,1	57,05	247	260	280 55
20	20	28,8	132,1	58,55	230	250	270 55
22	22,1	31,8	135,1	60,05	222	250	270 55
25	25,2	36,2	139,6	62,3	208	250	270 55
28	28,3	40,7	144,1	64,55	197	250	270 55

(\*) Intermittent: cycle 20 sec. ON & 3 sec. OFF - Peak: cycle 1 sec. ON & 3 sec. OFF  
 (\*) Intermittente: ciclo 20 sec. ON & 3 sec. OFF - Picco: ciclo 1 sec. ON & 3 sec. OFF

**PUMP PERFORMANCE CURVES**  
For Group 2

GROUP 2 Displacement CC/Rev

**CURVE PRESTAZIONI POMPE**  
per Gruppo 2

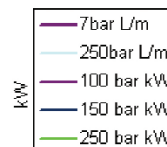
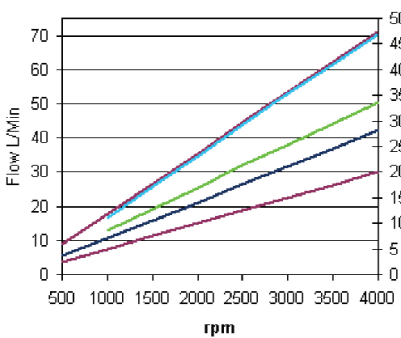
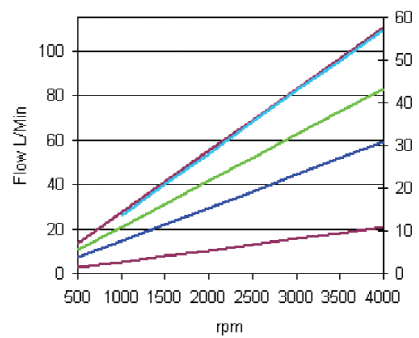
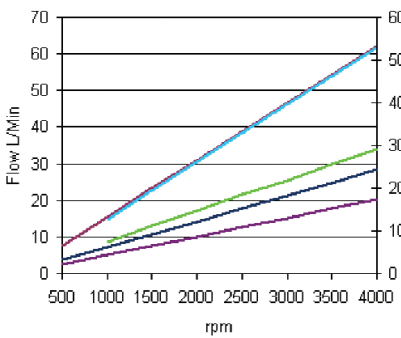
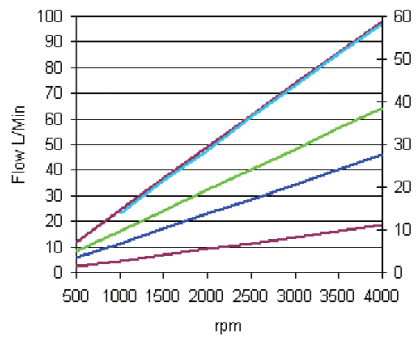
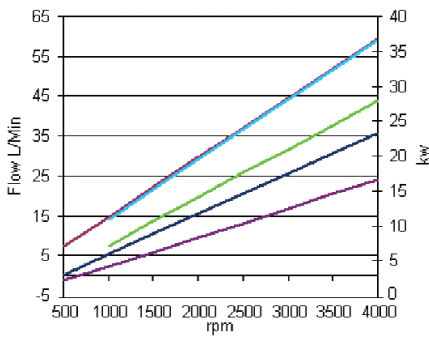
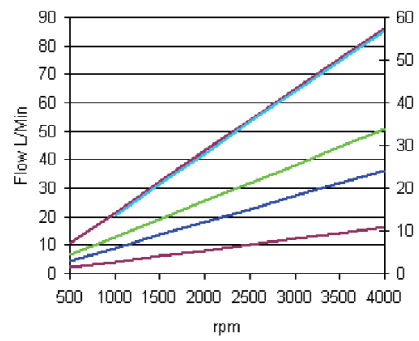
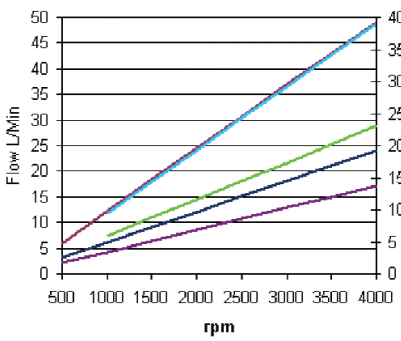
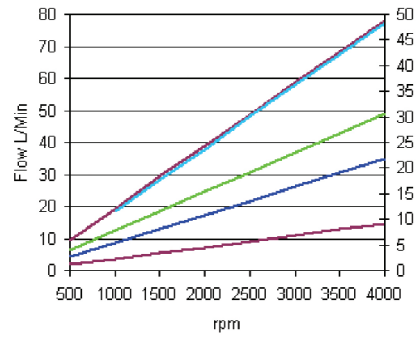
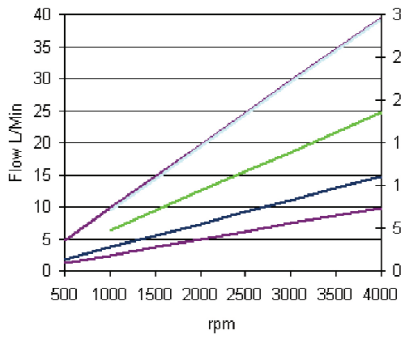

## Dimensional drawing - GR47

Shaft types & dimensions

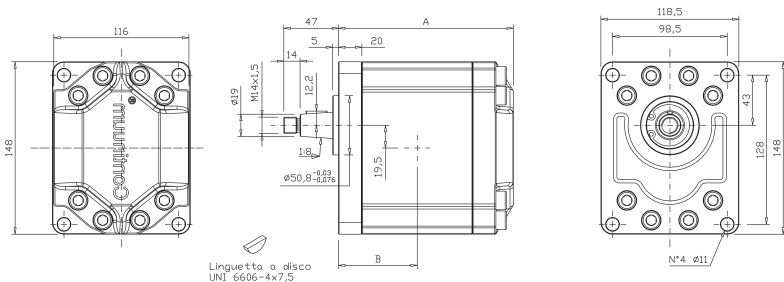

### PORTA TIPO O

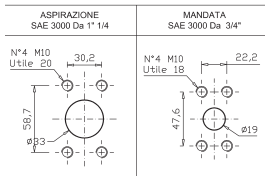

## Disegni dimensionali - GR47

Tipo albero e dimensioni

### Type / Tipo 3-C9

Type / Tipo	CC	L/min	Dim A	Dim B	Cont Press (*)	Interm Press	Peak / Press Press / Picco	Noise / Livello Level / Rumore
28	28	40,3	150,1	67,55	270	280	300	57
32	32,2	46,3	154,1	69,55	252	270	280	57
36	36,3	52,3	158,1	71,55	239	250	270	57
40	40,5	58,3	162,1	73,55	225	250	270	57
45	45,1	65,0	166,6	75,8	213	250	270	57
50	50,3	72,4	171,6	78,3	202	250	270	57

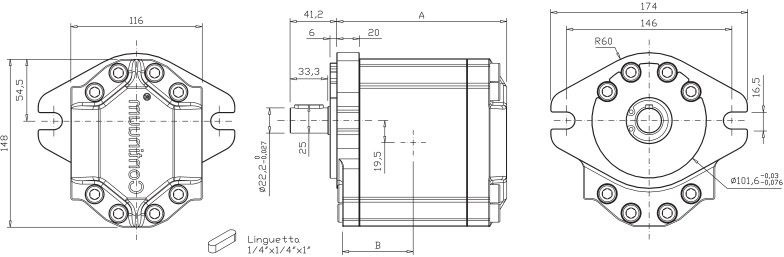

### PORTA TIPO O

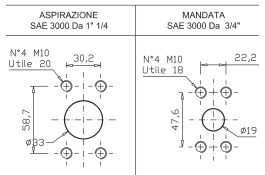

### Type / Tipo SAEB-AC

Type / Tipo	CC	L/min	Dim A	Dim B	Cont Press (*)	Interm Press	Peak / Press Press / Picco	Noise / Livello Level / Rumore
28	28	40,3	150,1	67,55	270	280	300	57
32	32,2	46,3	154,1	69,55	252	270	280	57
36	36,3	52,3	158,1	71,55	239	250	270	57
40	40,5	58,3	162,1	73,55	225	250	270	57
45	45,1	65,0	166,6	75,8	213	250	270	57
50	50,3	72,4	171,6	78,3	202	250	270	57

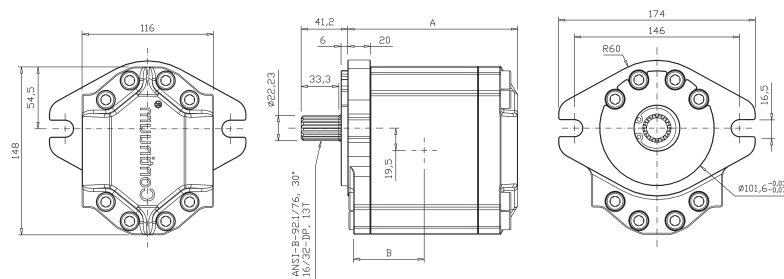

### PORTA TIPO O

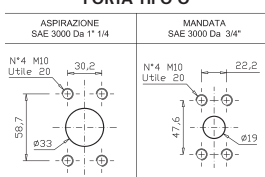

### Type / Tipo SAEB-T13

Type / Tipo	CC	L/min	Dim A	Dim B	Cont Press (*)	Interm Press	Peak / Press Press / Picco	Noise / Livello Level / Rumore
28	28	40,3	150,1	67,55	270	280	300	57
32	32,2	46,3	154,1	69,55	252	270	280	57
36	36,3	52,3	158,1	71,55	239	250	270	57
40	40,5	58,3	162,1	73,55	225	250	270	57
45	45,1	65,0	166,6	75,8	213	250	270	57
50	50,3	72,4	171,6	78,3	202	250	270	57

(\*) Intermittent: cycle 20 sec. ON & 3 sec. OFF - Peak: cycle 1 sec. ON & 3 sec. OFF  
 (\*) Intermittente: ciclo 20 sec. ON & 3 sec. OFF - Picco: ciclo 1 sec. ON & 3 sec. OFF



## Dimensional drawing - GR55

Shaft types & dimensions

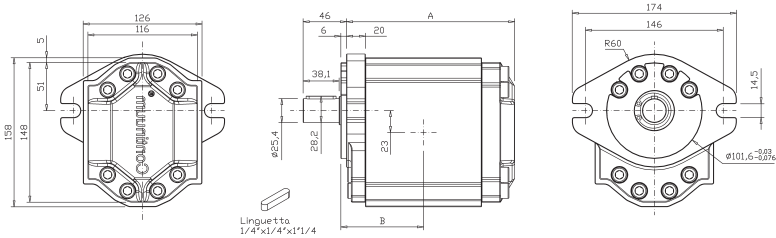

### PORTA TIPO O

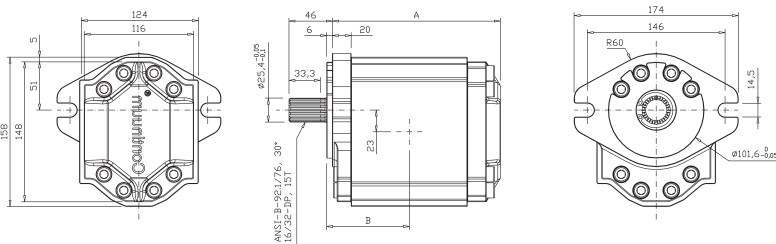
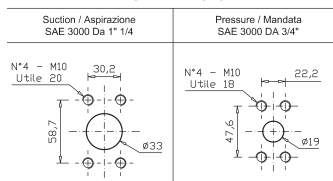

### PORTA TIPO O

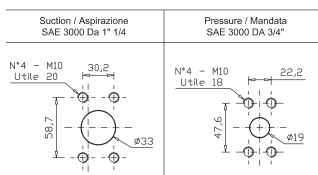

## Dimensional drawing - GR72

Shaft types & dimensions

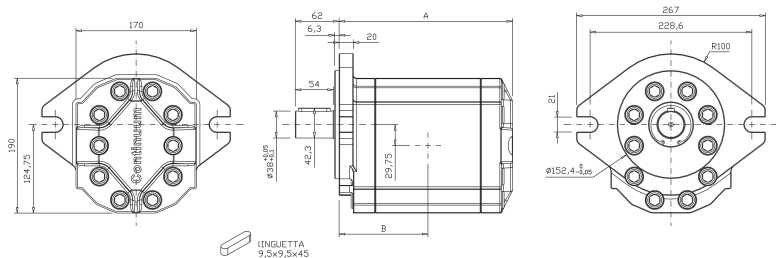

### PORTA TIPO M

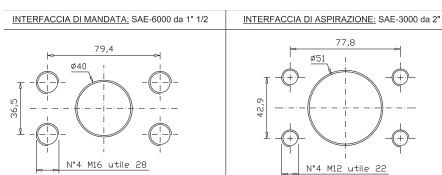

## Disegni dimensionali - GR55

Tipo albero e dimensioni

### Type / Tipo SAEB-AC

Type / Tipo	CC	L/min	Dim A	Dim B	Cont Press (*)	Interm Press	Peak / Press Press / Picco	Noise / Livello Level / Rumore
50	50,5	72,7	178,1	81,55	275	280	300	57
63	63,5	91,4	187,1	86,05	249	260	280	57
75	75	108,1	195,1	90,05	229	250	270	57
90	90,9	130,9	206,1	95,55	178	240	260	57

### Type / Tipo SAEB-T15

Type / Tipo	CC	L/min	Dim A	Dim B	Cont Press (*)	Interm Press	Peak / Press Press / Picco	Noise / Livello Level / Rumore
50	50,5	72,7	178,1	81,55	275	280	300	57
63	63,5	91,4	187,1	86,05	249	260	280	57
75	75	108,1	195,1	90,05	229	250	270	57
90	90,9	130,9	206,1	95,55	178	240	260	57

## Disegni dimensionali - GR72

Tipo albero e dimensioni

### Type / Tipo SAED-AAC

Type / Tipo	CC	L/min	Dim A	Dim B	Cont Press (*)	Interm Press	Peak / Press Press / Picco	Noise / Livello Level / Rumore
94	94,1	136	245,2	125,6	270	280	300	57
101	101,45	147	248,2	127,1	252	270	300	57
125	125,5	181	258,2	132,1	239	250	300	57
150	150,9	218	268,7	137,35	225	250	275	57
175	175	253	278,7	142,35	213	250	275	57
200	200,4	290	289,2	147,6	202	250	275	57

(\*) Intermittent: cycle 20 sec. ON & 3 sec. OFF - Peak: cycle 1 sec. ON & 3 sec. OFF  
 (\*) Intermittente: ciclo 20 sec. ON & 3 sec. OFF - Picco: ciclo 1 sec. ON & 3 sec. OFF

## Component description

- 1 Flange/Flangia
- 2 O-ring seal/O-ring
- 3 Centring key /Spine di centraggio
- 4 Body/Corpo
- 5 Bushings/Bronzine
- 6 O-ring seal/O-ring
- 7 Motor flange/Flangia motore

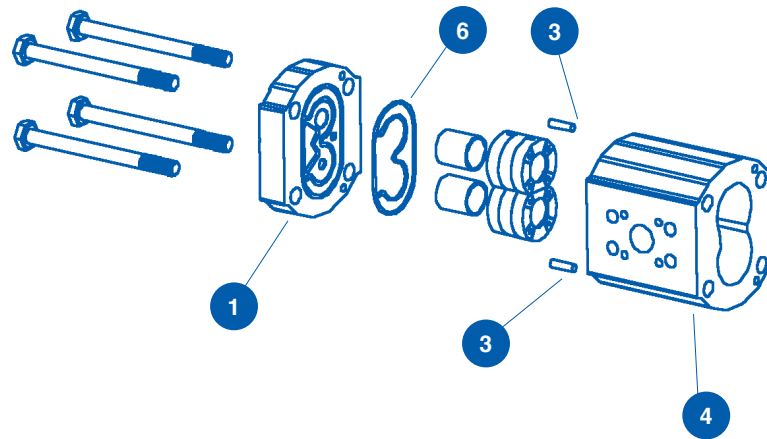

### Dimensional drawing Tandem Group 2 + 2

For unit dimensions please refer to GR33 and GR38 dimensional drawings

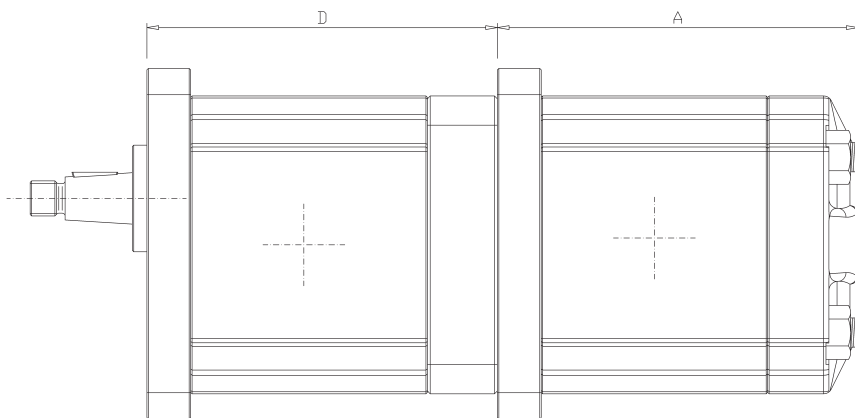

### Disegni dimensionali Tandem Gruppo 2+Gruppo 2

Per dimensionali delle singole pompe vedere sezioni precedenti

Front Pump	CC	Dim D	Cont Pres	Intern Press	Peak Press	Noise Level
GR33	010	113,6	275	280	300	55
	013	118,5	265	270	300	55
	015	123,5	241	250	300	55
	018	129,3	206	250	300	55
GR38	016	120,1	265	280	300	55
	018	123,1	247	260	300	55
	020	126,1	230	250	300	55
	022	129,1	222	250	300	55
	025	133,6	208	250	300	55
028	138,1	197	250	300	55	
		mm	bar	bar	bar	dB(A)

### Dimensional drawing Tandem Group 2 + 1

For unit dimensions please refer to GR33 and GR38 dimensional drawings

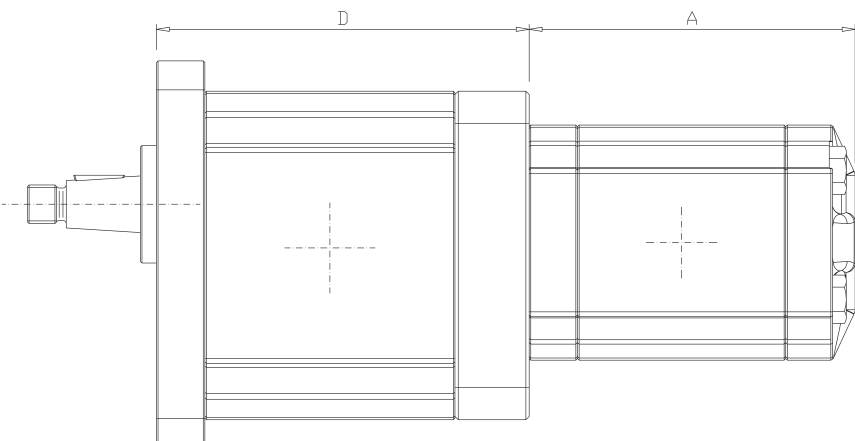

### Disegni dimensionali Tandem Gruppo 2+Gruppo 1

Per dimensionali delle singole pompe vedere sezioni precedenti

Front Pump	CC	Dim D	Cont Pres	Intern Press	Peak Press	Noise Level
GR33	010	115,6	275	280	300	55
	013	120,5	265	270	300	55
	015	125,5	241	250	300	55
	018	131,3	206	250	300	55
GR38	016	122,1	265	280	300	55
	018	125,1	247	260	300	55
	020	128,1	230	250	300	55
	022	131,1	222	250	300	55
	025	135,6	208	250	300	55
028	140,1	197	250	300	55	
		mm	bar	bar	bar	dB(A)

For dimension "A" make reference to pages 4-9  
Per la misura "A" fare riferimento alle pagine da 4 a 9

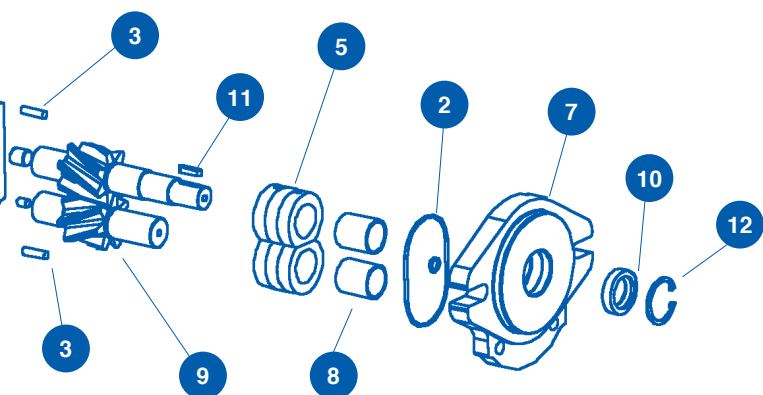

- 8 Bushings/Bronzine
- 9 Continuum® rotor/Rotore Continuum®
- 10 Seal/Anello di tenuta
- 11 Shaft key/Chiavetta
- 12 Seeger / Seeger

### Dimensional drawing Tandem Group 3 + 2

For unit dimensions please refer to GR33 and GR38 dimensional drawings

### Disegni dimensionali Tandem Gruppo 3 + Gruppo 2

Per dimensionali delle singole pompe vedere sezioni precedenti

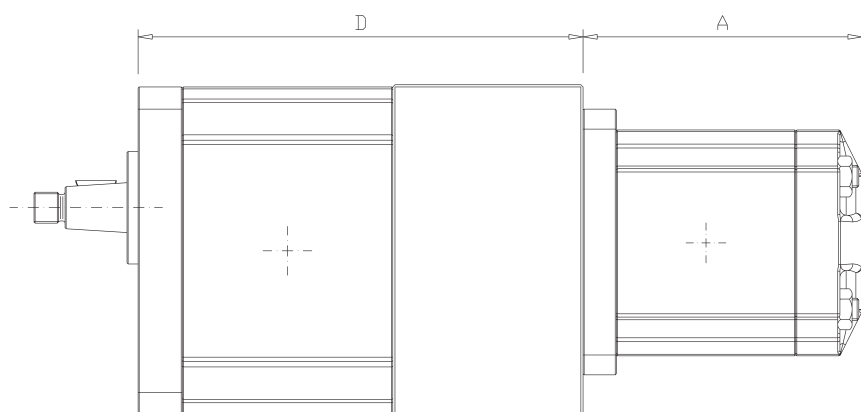

Front Pump	CC	Dim D	Cont Pres	Interm Press	Peak Press	Noise Level
GR47	28	201,1	270	280	300	57
	32	205,1	252	270	300	57
	36	209,1	239	250	300	57
	40	213,1	225	250	300	57
	45	217,6	213	250	300	57
	50	222,6	202	250	300	57
	mm		bar	bar	bar	dB(A)

### Dimensional drawing Tandem Group 3 + 3

For unit dimensions please refer to GR33 and GR38 dimensional drawings

### Disegni dimensionali Tandem Gruppo 3 + Gruppo 3

Per dimensionali delle singole pompe vedere sezioni precedenti

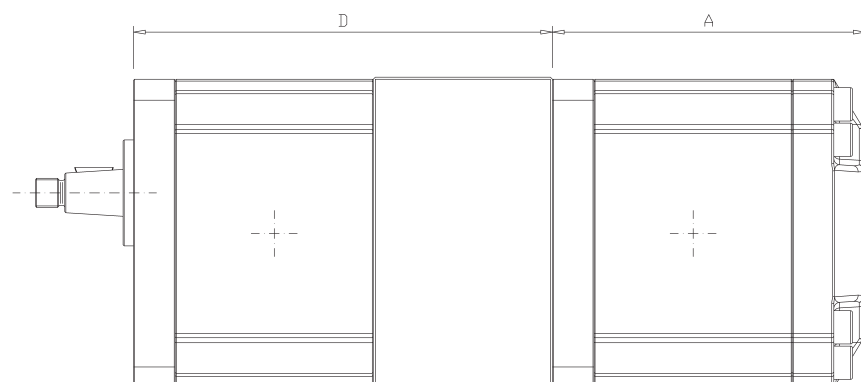

Front Pump	CC	Dim D	Cont Pres	Interm Press	Peak Press	Noise Level
GR47	28	201,1	270	280	300	57
	32	205,1	252	270	300	57
	36	209,1	239	250	300	57
	40	213,1	225	250	300	57
	45	217,6	213	250	300	57
	50	222,6	202	250	300	57
	mm		bar	bar	bar	dB(A)

For dimension "A" make reference to pages 4-9  
Per la misura "A" fare riferimento alle pagine da 4 a 9

## Ordering code / Codice d'ordinazione

**DG\*\***    **2V**                    **\*\*\*CC**                    **F\*\*\*\*A\*\*\***    **\***    **GR\*\***                    **\*\*\*CC**                    **\***    **\***                    **\*\***  
**1**    **2**                                **3**                                **4**                                **5**                                **6**                                **7**                                **8**                                **9**                                **10**

Pump Type <i>Tipo</i>	Class <i>Classe</i>	Displacement <i>Cilindrata</i>	Flange & Shaft <i>Flangia &amp; Albero</i>	Ports <i>Porte</i>	Shaft Seal <i>Guarnizione Albero</i>	Rotation <i>Rotazione</i>
28		004-006-008-010-013	F1AC3-F1PAC2-F1KAG54-F1LAGL54	G	(none) V	DX (default)  SX
33		010-013-015-018	F2AC4-F2BK7AG-FSAEAAC-FSAEAAT9	G-M		
38		016-018-020-022-025-028	F2AC4-F2BK7AG-FSAEAAC-FSAEAAT11			
47		028-032-036-040-045-050	F3AC9-FSAEBAC-FSAEBAT13	O		
55		050-063-075-090	FSAEBAC-FSAEBAT15			
72		094-101-125-150-175-200	FSEADAC			

## Ordering code multiple pumps / Codice d'ordinazione pompe multiple

**DG\*\***    **2V**                    **\*\*\*CC**                    **F\*\*\*\*A\*\*\***    **\***    **GR\*\***                    **\*\*\*CC**                    **\***    **\***                    **\*\***  
**1**    **2**                                **3**                                **4**                                **5**                                **6**                                **7**                                **8**                                **9**                                **10**

Pump Type <i>Tipo</i>	Class <i>Classe</i>	Displacement 1st stage <i>Cilindrata primo stadio</i>	Flange & Shaft <i>Flangia &amp; Albero</i>	Ports <i>Porte</i>	Displacement 2nd stage <i>Cilindrata secondo stadio</i>	Ports <i>Porte</i>	Shaft Seal <i>Guarnizione Albero</i>	Rotation <i>Rotazione</i>
33		010-013-015-018	F2AC4	G-M	28	004-006-008-010-013	(none) V	DX (default)  SX
					33	010-013-015-018		
38		016-018-020-022-025-028	F2AC4		38	016-018-020-022-025-028		
					28	004-006-008-010-013		
					33	010-013-015-018		
47		028-032-036-040-045-050	F3AC9		38	016-018-020-022-025-028		
				33	010-013-015-018			
				47	028-032-036-040-045-050			
55		050-063-075-090	FSAEBAT15	O	33	010-013-015-018		
					38	016-018-020-022-025-028		
					47	028-032-036-040-045-050		
					55	050-063-075-090		

Group /  
Gruppo

### Product Range / Gamma Prodotti

Displacement (cc/rev) <i>Cilindrata</i>	1	<b>GR28</b> 4,2 6,4 8,3 10,2 12,9
	2	<b>GR33</b> 10,1 12,6 15,2 18,2
		<b>GR38</b> 15,9 17,9 20,0 22,1 25,2 28,3
	3	<b>GR47</b> 28,0 32,2 36,3 40,5 45,1 50,3
<b>GR55</b> 50,5 63,5 75,0 90,9		
4	<b>GR72</b> 94,1 101,4 125,5 150,9 175,0 200,4	
	6            10            18            28            50            90            200	



Cont\_ITA-UK\_1.1

Area Agency/Reseller

**Main Office: Settima Flow Mechanisms s.r.l.**  
 29020 Loc. Conca di Settima - Gossolengo (PC) - Italy  
 Tel: +39 0523 557623  
 Fax: +39 0523 557256  
 www.settimafm.com - info@settimafm.com

